

## Sink Leonardo 40" x 20" 2B – U/M

Kitchen Sinks

Code: 1016 660

AISI 304 Stainless steel

Satin finish

Undermount

x cross bending for easy water draining



### DETAILS

|                        |  |
|------------------------|--|
| Edge/Installation Type | Undermount   |
| <b>Series</b>          | Leonardo   |
| Texture                | Satin  |
| Material               | AISI 304 stainless steel   |
| Thickness              | 16 Gauge (1.5 mm)  |
| Overall dimensions     | 39 <sup>5</sup> / <sub>8</sub> " x 19 <sup>5</sup> / <sub>16</sub> "         |
| Bowls dimensions       | 2 bowls 18 <sup>3</sup> / <sub>16</sub> " x 15 <sup>3</sup> / <sub>4</sub> " |
| Bowls depht            | 10 "   |

|                    |   |
|--------------------|---|
| Cut out            | 38 <sup>1</sup> / <sub>8</sub> " x 17 <sup>13</sup> / <sub>16</sub> " |
| Waste fitting type | 3 <sup>1</sup> / <sub>2</sub> " - with stainless steel basket         |
| Bowls bottom       | X cross bending for easy water draining                               |
| Underside          | Protected with heavy duty undercoating                                |
| Fixing system      | Undermount fixing kit (brass insert and clips)                        |

## FEATURES

|                                     |  |
|-------------------------------------|--|
| Diamond-shape bottom                | The draining of water is an important feature in a sink, and it's always taken good care of in Foster products. In the bent-welded sinks, which would have a flat bottom, the proper draining is guaranteed by the elegant beveling, which helps the water flow.   |
| High thickness                      | 1.5 mm thick steel. A significant thickness, which guarantees the maximum sturdiness and durability.   |
| Basket 3,5" waste fitting           | The drain is equipped with a large 3.5" drain, with the practical basket cap that prevents the discharge of solid parts.   |
| Triple recess - sliding accessories | The Foster Milano sink has an ingenious design that makes it simple to use a large set of optional accessories. On the topmost supporting step, the innovative Black grids slide, creating a large and practical surface to rinse food and crockery. The second step is meant to support and allow the sliding of a complete combination of accessories, which make some operations practical and safe: rinse, drain, slice, grate... everything can be done inside the sink. The third supporting step is on the bottom of the bowl. On this step one can rest the Black grids, making it possible to rinse foodstuffs without their coming in contact with the bottom of the sink, which may be dirty. |

## TECHNICAL DATA

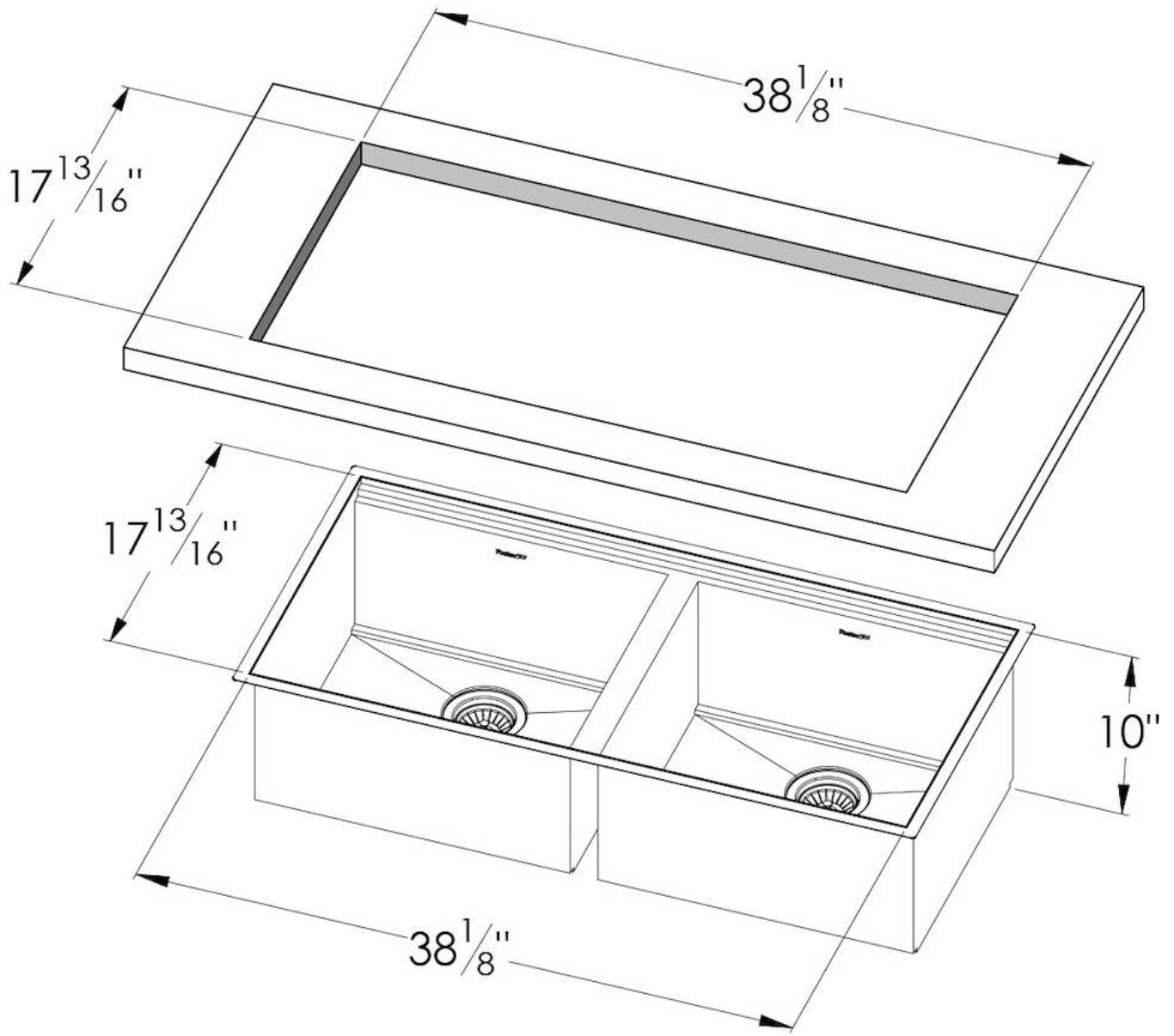

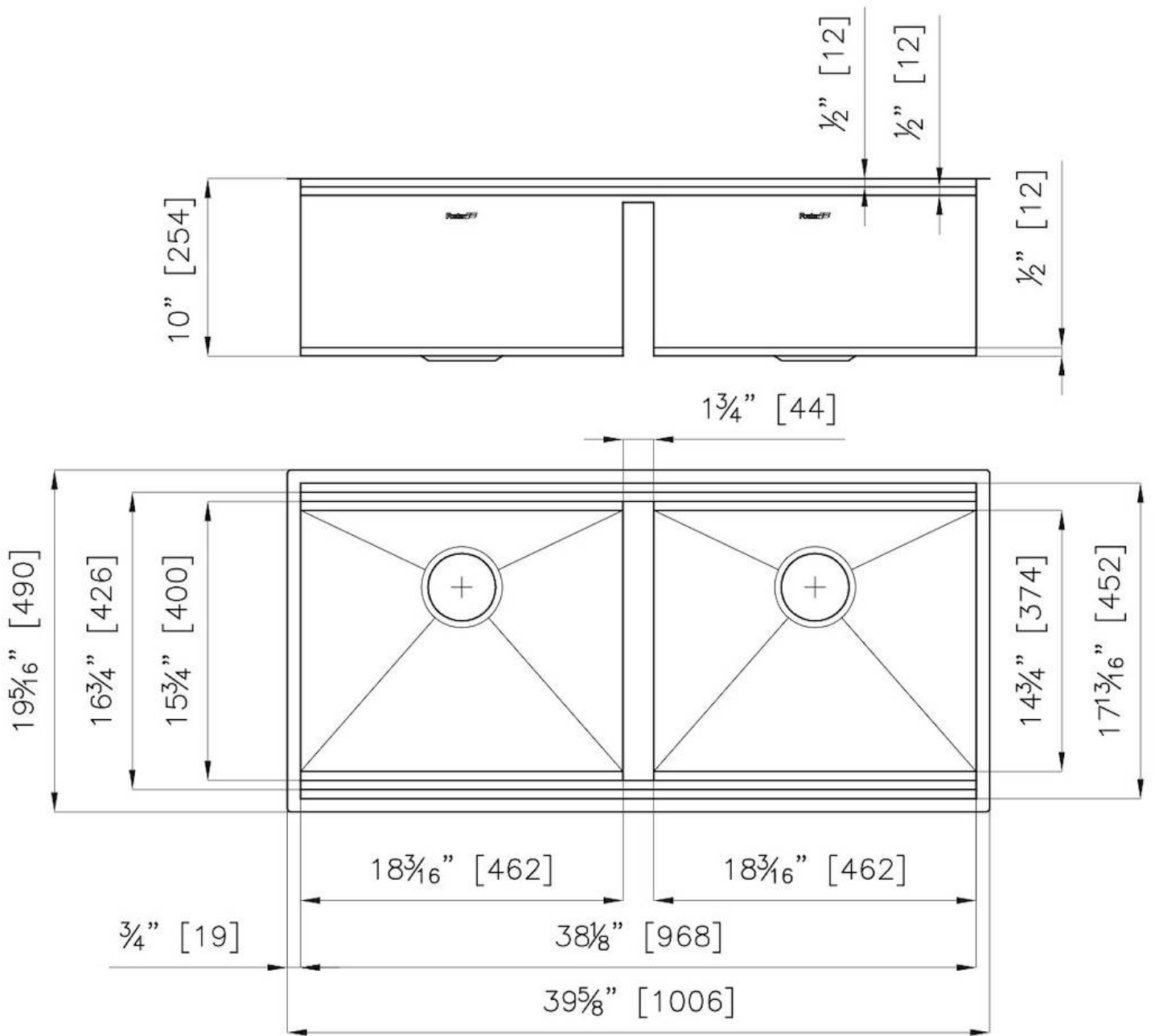

## Leonardo Optional accessories

The "rails" system makes it possible to use a combination of numerous accessories. Grids, chopping boards, utensils' ranging system, bowls and containers of different dimensions can be alternated in the workspace with a simple gesture, and can easily be stacked, in order to be on hand at all times.

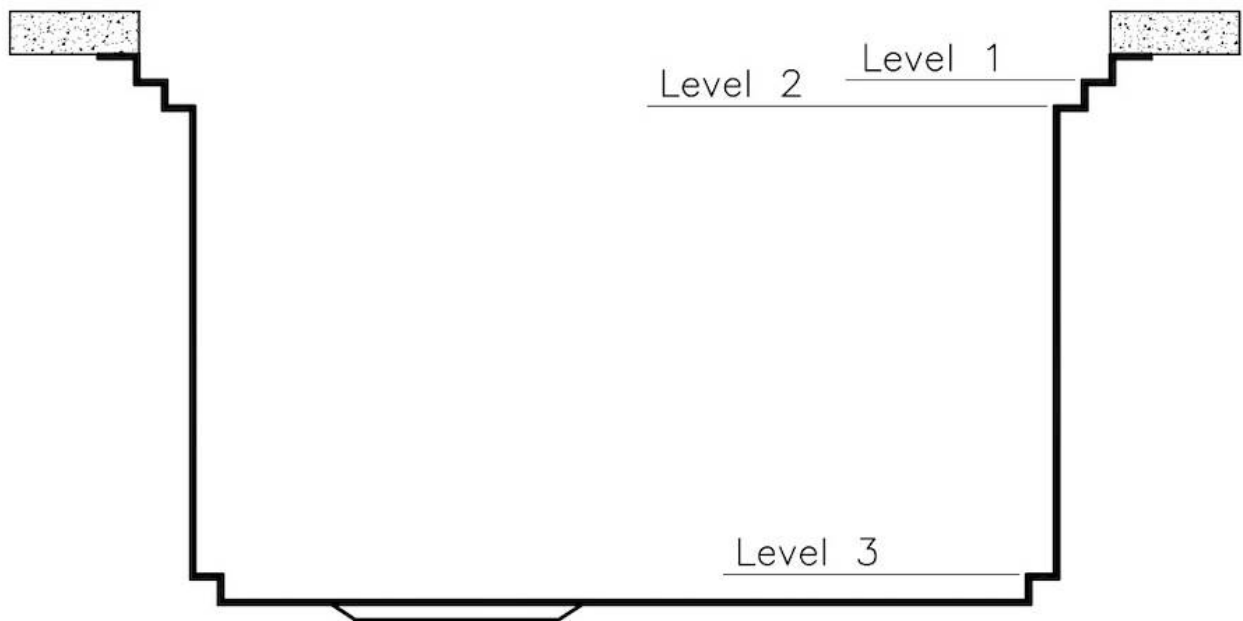

## Leonardo Level 1

Compatible accessories:

8100 600

8100 601

8100 620

8100 621

8100 622

8642 000

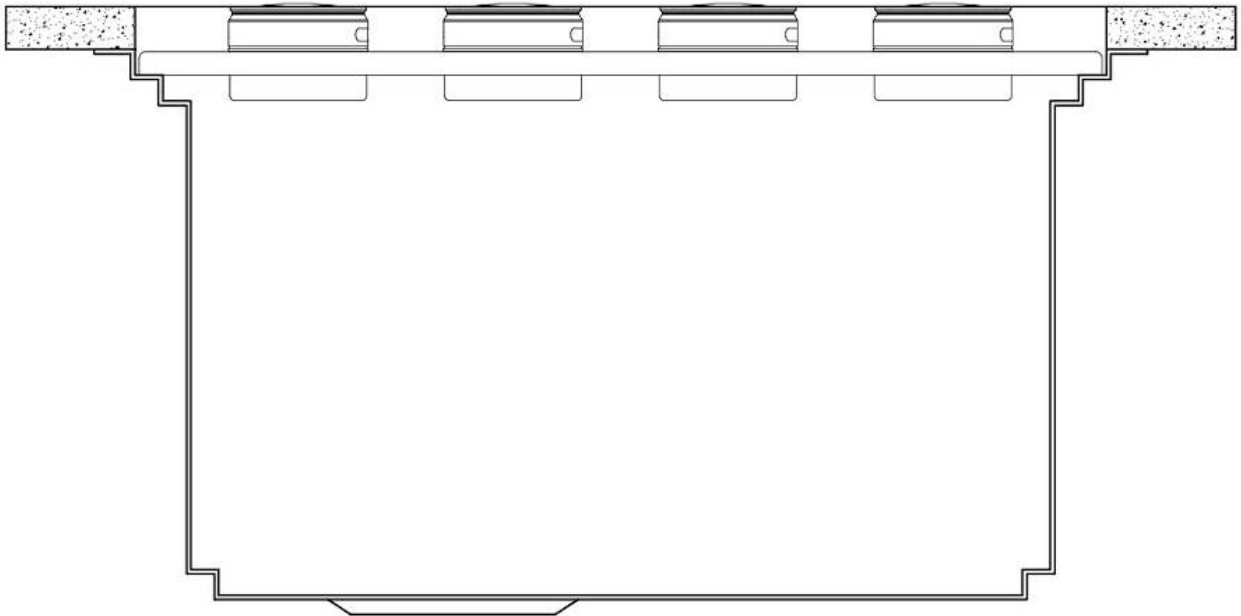

## Leonardo Level 2

Compatible accessories:

8153 100

8631 300

8644 101



## Leonardo Level 3

Compatible accessories:

8100 600





Edge  
positioning

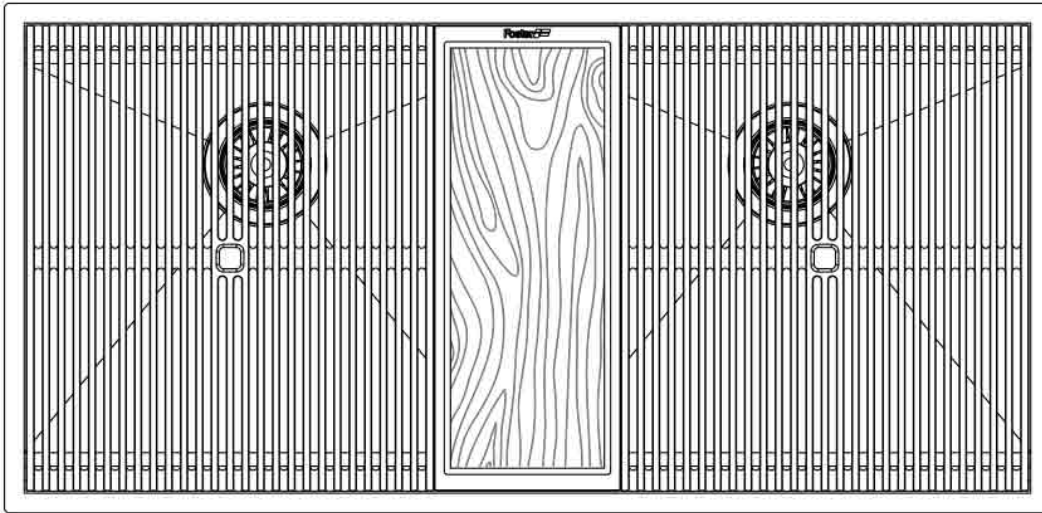

8100 600    8642 000    8100 600

8100 600

8100 600

Bottom  
positioning

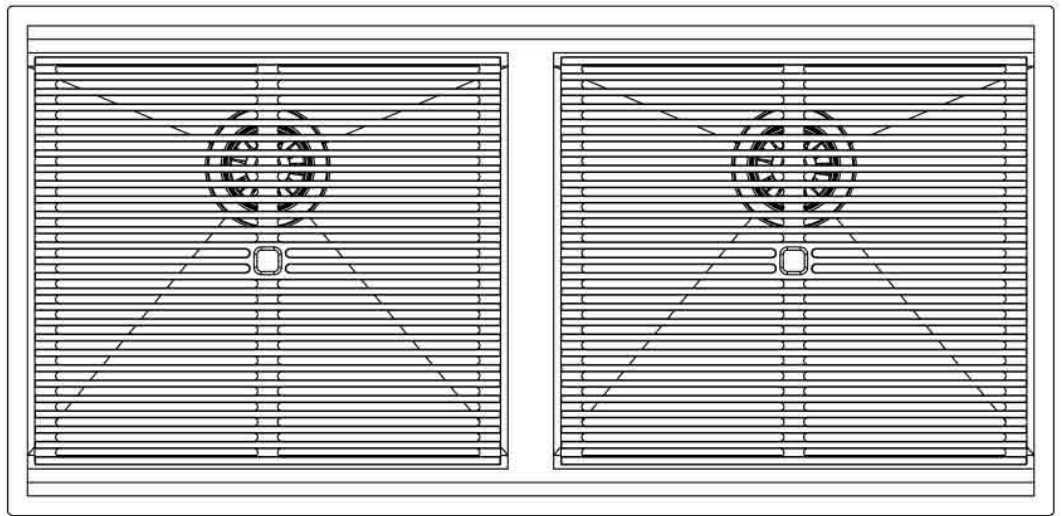

## GALLERY



## OPTIONAL ACCESSORIES



3 Bottles-holder set



3 Bowls set



4 Spices-holder set



Black Grid



Chopping Board



Chopping Board



Grating kit complete with ring support and food collection tray

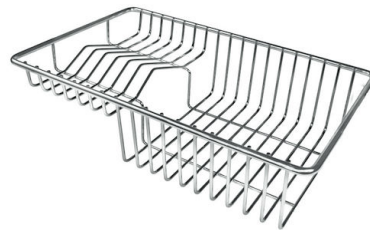

Stainless Steel dishes holder



Stainless steel perforated pan



Twin Chopping Board



Waste disposer throat



White bowl

**WARNING:**

The accessories 8159101, 8100303, 8151000 are only usable in combination with 8644101

## RECOMMENDED PAIRINGS



Faucet Capri



Faucet Salina



Milano Cooktop 6 burners



Milano Induction Cooktop 5 Plate