

## Sink Leonardo 40" x 20" 2B – U/M

Kitchen Sinks

Code: 1016 660

AISI 304 Stainless steel

Satin finish

Undermount

x cross bending for easy water draining



### DETAILS

<b>Series</b>	Leonardo
<b>Material</b>	AISI 304 stainless steel
<b>Texture</b>	Satin
<b>Edge/Installation Type</b>	Undermount
<b>Thickness</b>	16 Gauge (1.5 mm)
<b>Overall dimensions</b>	39 <sup>5</sup> / <sub>8</sub> " x 19 <sup>5</sup> / <sub>16</sub> "
<b>Bowls dimensions</b>	2 bowls 18 <sup>3</sup> / <sub>16</sub> " x 15 <sup>3</sup> / <sub>4</sub> "
<b>Bowls depth</b>	10"

Cut out	38 <sup>1</sup> / <sub>8</sub> " x 17 <sup>13</sup> / <sub>16</sub> "
Waste fitting type	3 <sup>1</sup> / <sub>2</sub> " - with stainless steel basket
Bowls bottom	X cross bending for easy water draining
Underside	Protected with heavy duty undercoating
Fixing system	Undermount fixing kit (brass insert and clips)

## FEATURES

Diamond-shape bottom	The draining of water is an important feature in a sink, and it's always taken good care of in Foster products. In the bent-welded sinks, which would have a flat bottom, the proper draining is guaranteed by the elegant beveling, which helps the water flow.
High thickness	1.5 mm thick steel. A significant thickness, which guarantees the maximum sturdiness and durability.
Basket 3,5" waste fitting	The drain is equipped with a large 3.5" drain, with the practical basket cap that prevents the discharge of solid parts.
Triple recess - sliding accessories	The Foster Milano sink has an ingenious design that makes it simple to use a large set of optional accessories. On the topmost supporting step, the innovative Black grids slide, creating a large and practical surface to rinse food and crockery. The second step is meant to support and allow the sliding of a complete combination of accessories, which make some operations practical and safe: rinse, drain, slice, grate... everything can be done inside the sink. The third supporting step is on the bottom of the bowl. On this step one can rest the Black grids, making it possible to rinse foodstuffs without their coming in contact with the bottom of the sink, which may be dirty.

## TECHNICAL DATA

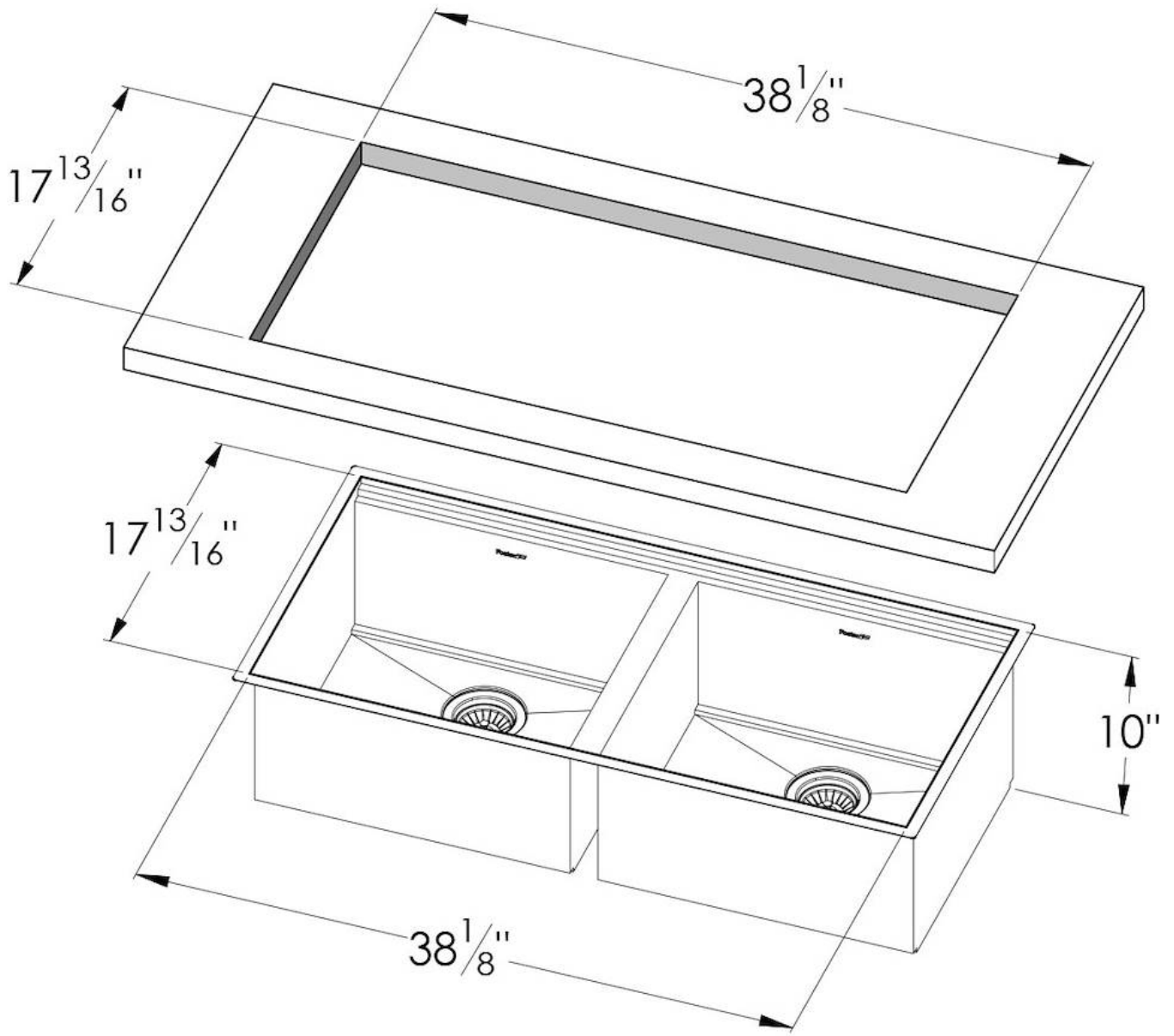

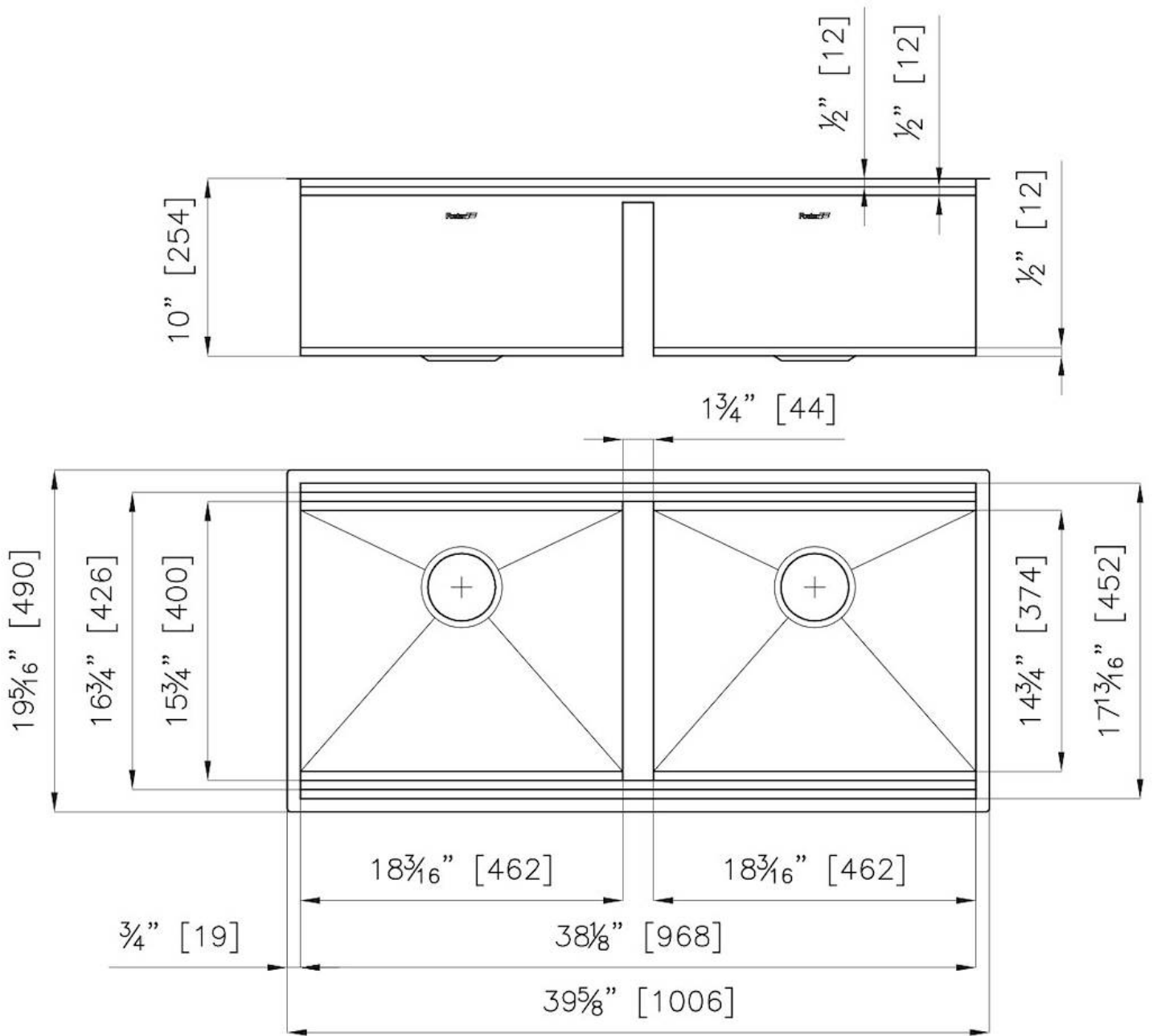

## Leonardo Optional accessories

The "rails" system makes it possible to use a combination of numerous accessories. Grids, chopping boards, utensils' ranging system, bowls and containers of different dimensions can be alternated in the workspace with a simple gesture, and can easily be stacked, in order to be on hand at all times.

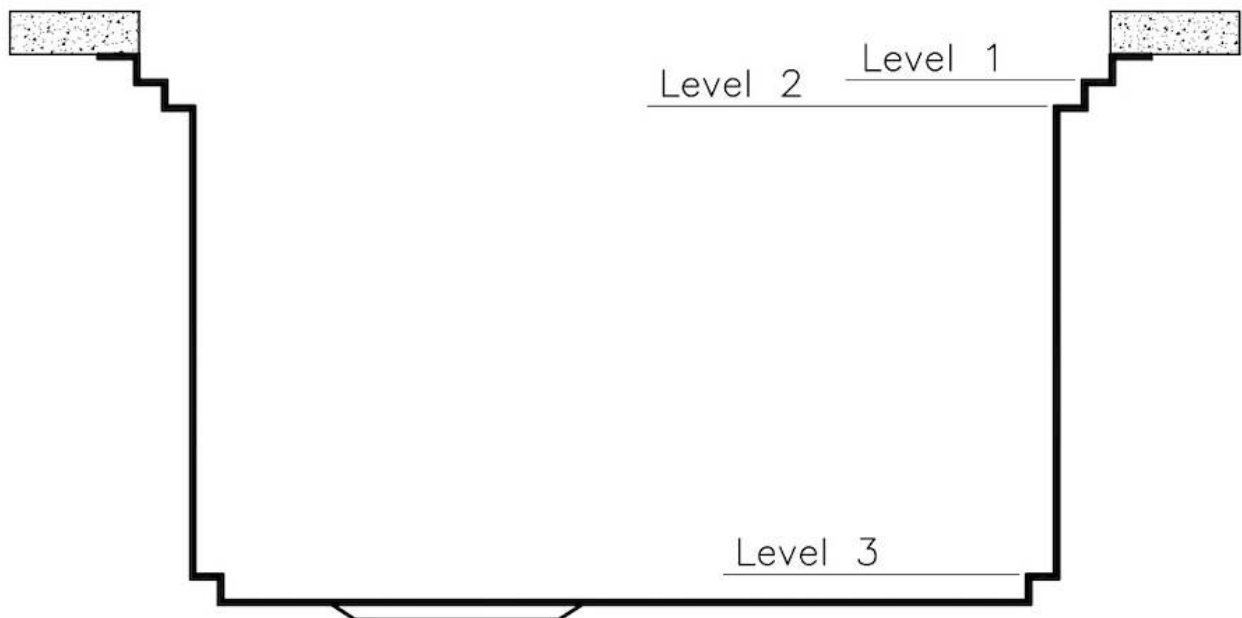

## Leonardo Level 1

Compatible accessories:

8100 600  
8100 601  
8100 620  
8100 621  
8100 622  
8642 000

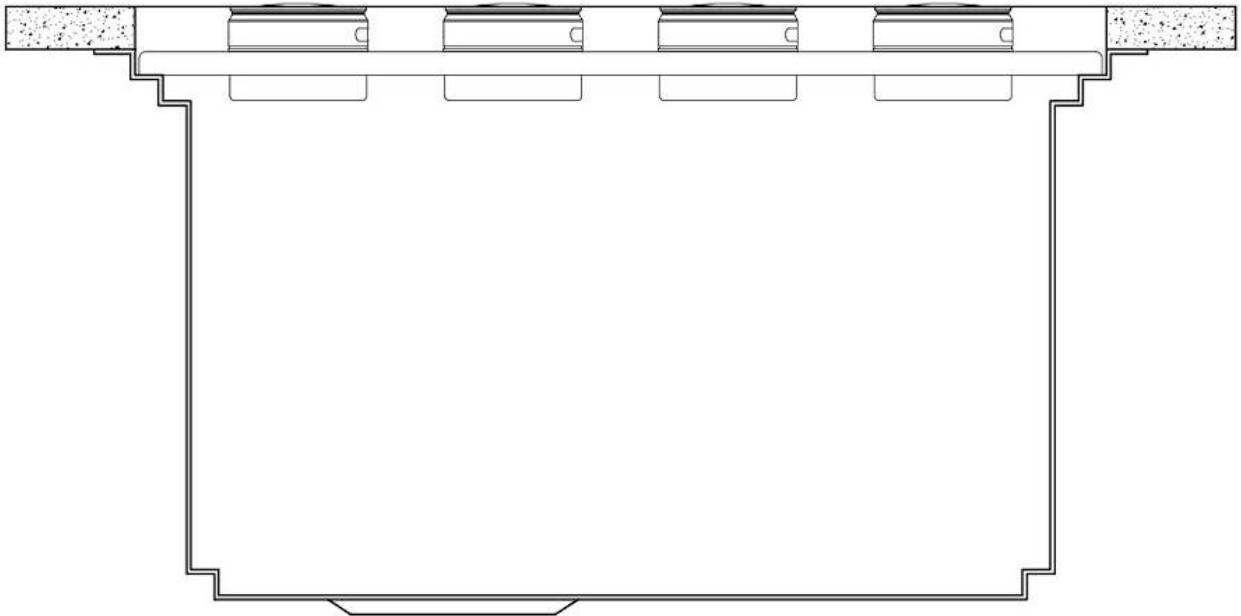

## Leonardo Level 2

Compatible accessories:

8153 100

8631 300

8644 101



## Leonardo Level 3

Compatible accessories:

8100 600



Edge  
positioning

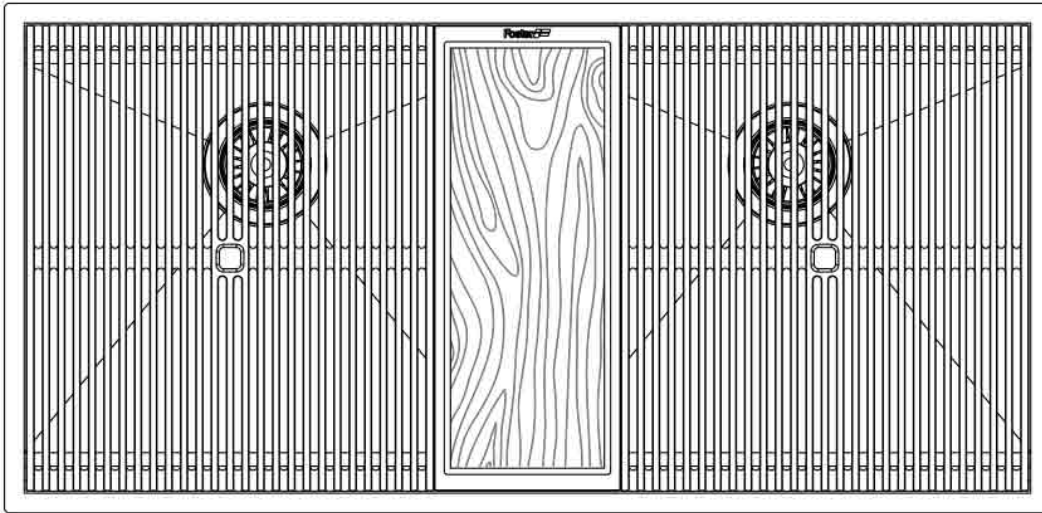

8100 600    8642 000    8100 600

8100 600

8100 600

Bottom  
positioning

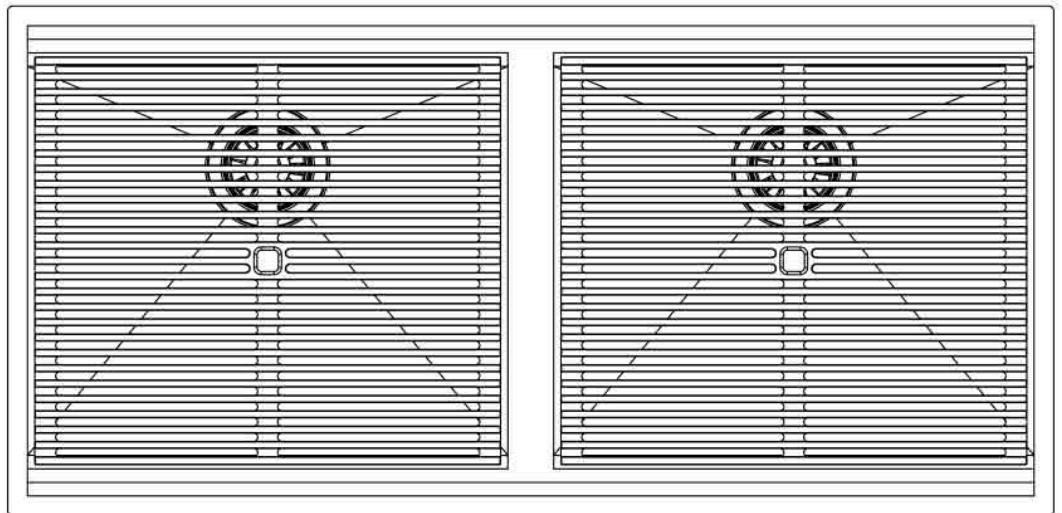

## OPTIONAL ACCESSORIES



**3 Bottles-holder set**  
8100 621



**3 Bowls set**  
8100 622



**4 Spices-holder set**  
8100 620



**Black Grid**  
8100 600



**Chopping Board**  
8631 300



**Grating kit complete with ring support and food collection tray**

8159 101

\* only in combination with the accessory  
8644 101

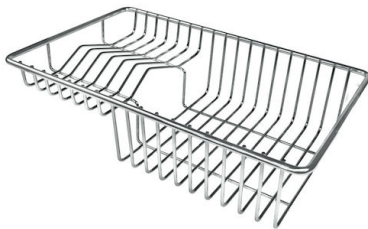

**Stainless Steel dishes holder**  
8100 303

\* only in combination with the accessory  
8644 101



**Stainless steel perforated pan**  
8151 000

\* only in combination with the accessory  
8644 101



**Twin Chopping Board**  
8644 101



**Waste disposer throat**  
8669 043



**White bowl**  
8153 100



**Chopping Board**  
8642 000



**Iroko-wood round chopping board**  
8642 005

## RECOMMENDED PAIRINGS



**Faucet Capri**  
8467 005



**Faucet Capri | Satin finish**  
8467 105

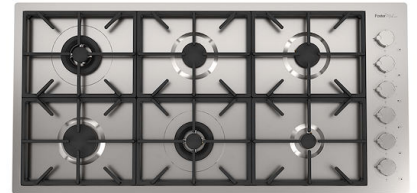

**Milano Cooktop 6 burners**  
7639 900

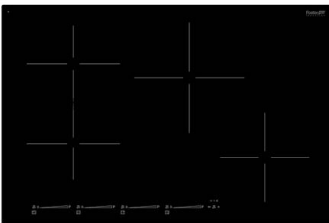

**Induction Cooktop 30"**  
7371 947