

Sink Canova 32" x 20" – U/M

Kitchen Sinks

Code: 1337 660

AISI 304 Stainless steel

Satin finish

Undermount

x cross bending for easy water draining

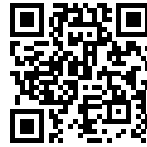

DETAILS

Series Canova

Material AISI 304 stainless steel

Finish Satin finish

Thickness 16 Gauge (1.5 mm)

Inset type Undermount

Overall dimensions 31 1/2" x 19 1/2"

Bowl dimension 1 bowl 30" x 17"

Bowls depht 10 "

Cut out	30" x 18"
Waste fitting type	3 1/2" - with stainless steel basket
Bowls bottom	X cross bending for easy water draining
Underside	Protected with heavy duty undercoating
Fixing system	Undermount fixing kit (brass insert and clips)

FEATURES

Diamond-shape bottom	The draining of water is an important feature in a sink, and it's always taken good care of in Foster products. In the bent-welded sinks, which would have a flat bottom, the proper draining is guaranteed by the elegant beveling, which helps the water flow.
Double recess	The "rails" system makes it possible use a combination of numerous accessories. Grids, Chopping boards, utensils' ranging systems, bowls and containers of different dimension can be alternates in the workspace with a simple gesture, and can easily be stacked, in order to be on hand at all times.
High thickness	1.5 mm thick steel. A significant thickness, which guarantees the maximum sturdiness and durability.
Basket 3,5" waste fitting	The drain is equipped with a large 3.5" drain, with the practical basket cap that prevents the discharge of solid parts.

TECHNICAL DATA

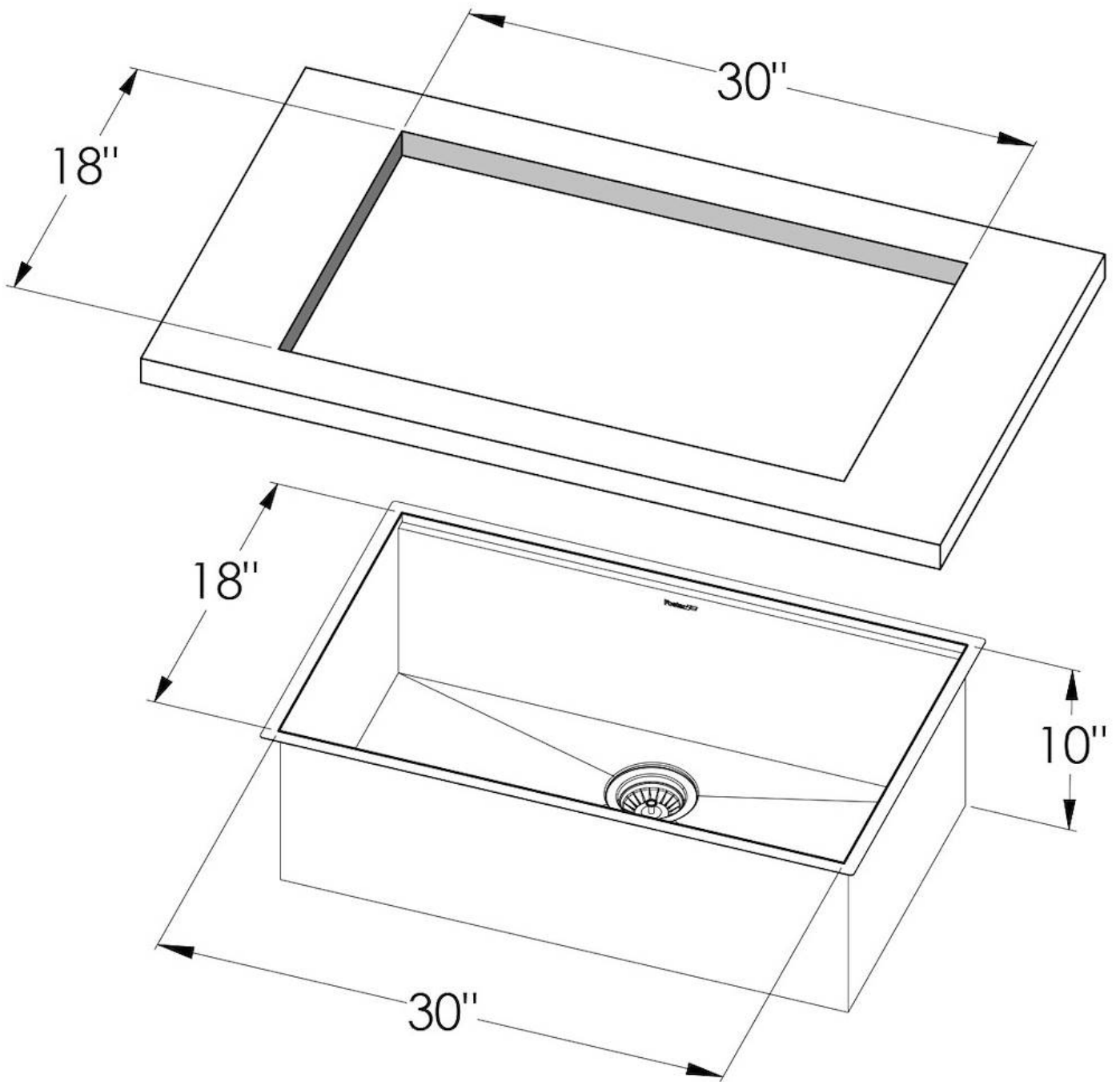

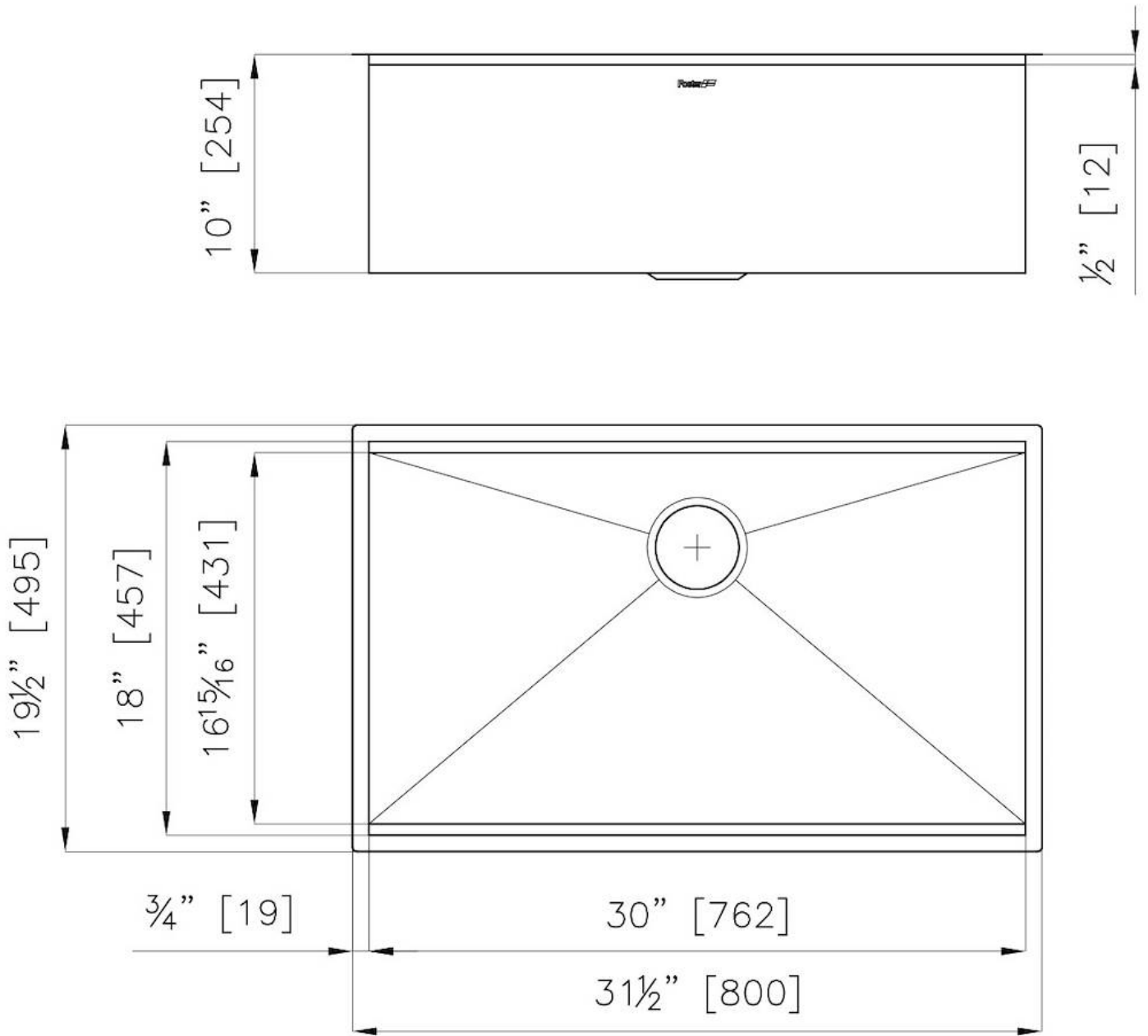

Canova Optional accessories

The "rails" system makes it possible to use a combination of numerous accessories. Grids, chopping boards, utensils' ranging system, bowls and containers of different dimensions can be alternated in the workspace with a simple gesture, and can easily be stacked, in order to be on hand at all times.

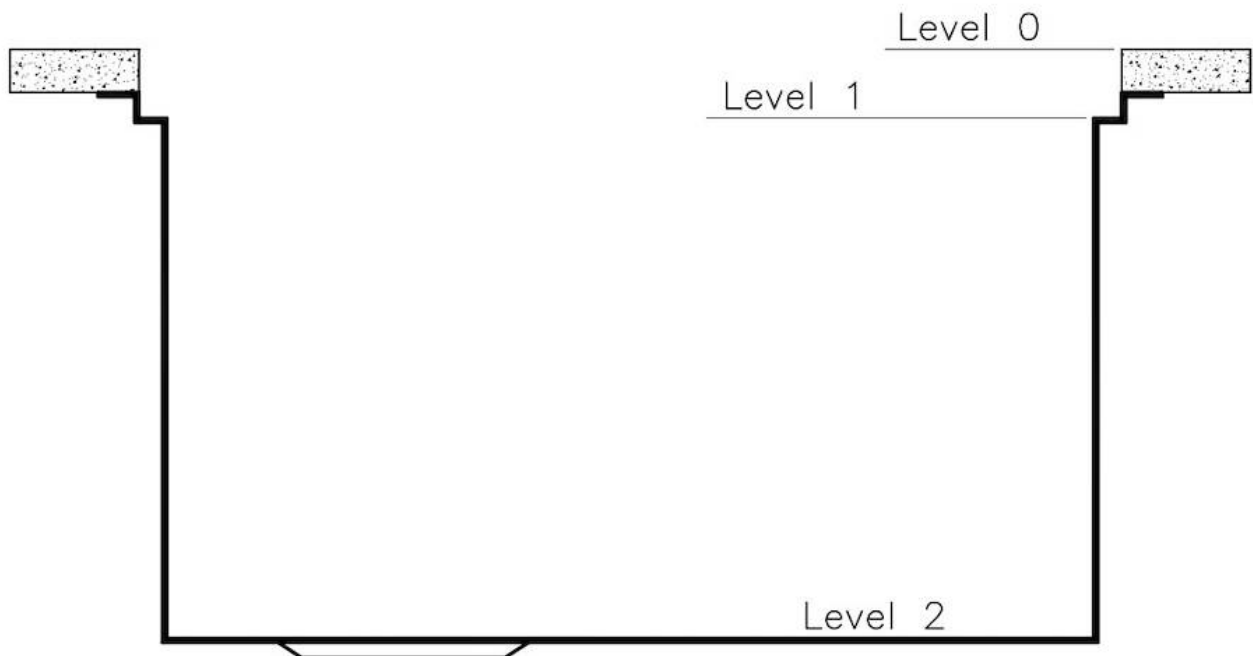

Canova Level 0

Compatible accessories:

8644 102



Canova Level 1

Compatible accessories:

8100 605

8644 104



Canova Level 2

Compatible accessories:

8100 605

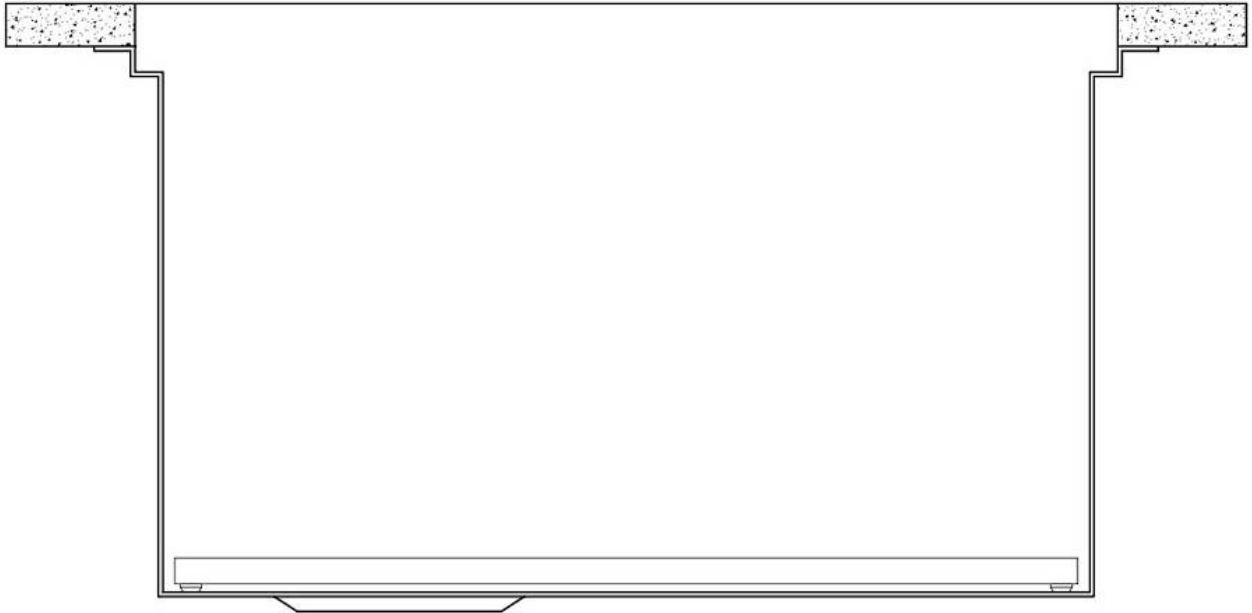

Edge positioning

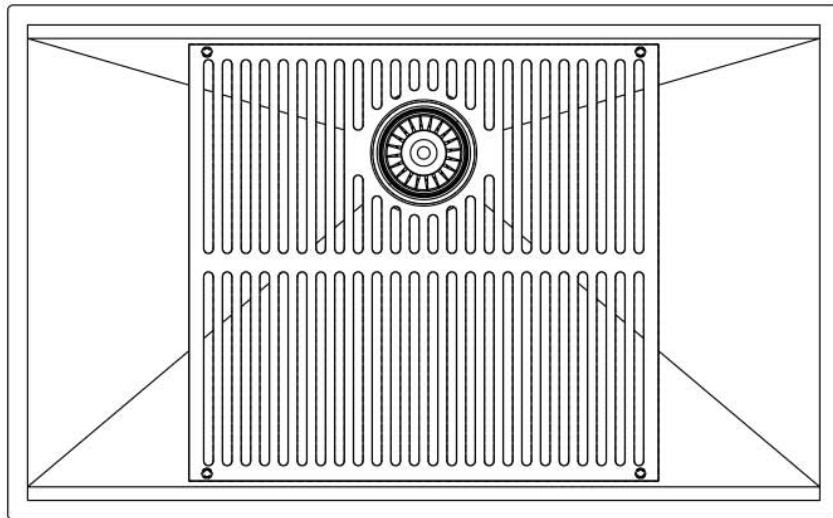
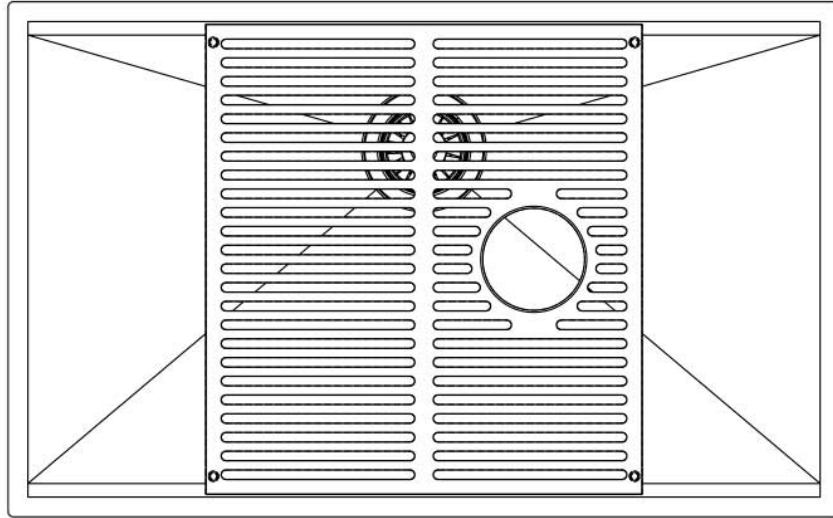

Bottom positioning

GALLERY



OPTIONAL ACCESSORIES



Bottle holder

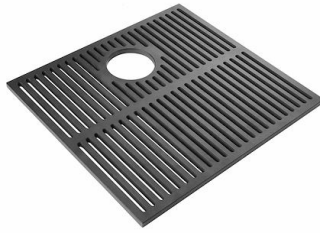

Canova Black grid



Grating kit complete with ring support and food collection tray



Knives-holder

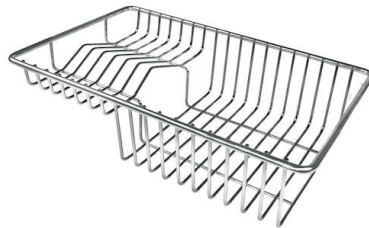

Stainless Steel dishes holder



Stainless steel perforated pan



Twin Chopping Board



Twin Chopping Board in HDPE



Waste disposer throat

WARNING:

The accessories 8159101, 8100303, 8151000 are only usable in combination with 8644102

RECOMMENDED PAIRINGS



Faucet Capri



Faucet Salina



Milano Cooktop 4 burners

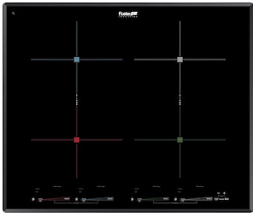

Milano Induction Cooktop 4 Plate