



Hood Milano Wall

Hoods

Code: 2456 911

Wall-mounted suction hood

Satin finish stainless steel

4 speed

Aluminium die-cast motor housing



DETAILS

Hood type Wall-mounted suction Hood

Hood finishing Satin Finish stainless steel

Dimensions
2456 911 (30"): 30.5" x 19.7" x min 24.8" / max 41.3"
2456 901 (36"): 35.4" x 19.7" x min 24.8" / max 41.3"
2457 901 (48"): 47.2" x 19.7" x min 24.8" / max 41.3"

Control type Button panel

Speed 4 speed

Grease filters Filter in anodized aluminium (5+1 layers)

Charcoal filters Optional

Lighting 2 x 2.1 W Led spotlight - 4,000°K

Delay off timer Yes

Light switch Yes

Air Outlet 3.5 ^{29/32}"

Model Aluminium die-cast motor housing

Air flow rate 600 CFM

Pressure 680 Pa

Noise level 64 dBA

Electrical requirements 120VAC – 60Hz

Max Amp usage, power rating 3,5A

Accessories Charcoal filters kit - 9700 901

Certifications CSA Certified for US & Canada

TECHNICAL DATA

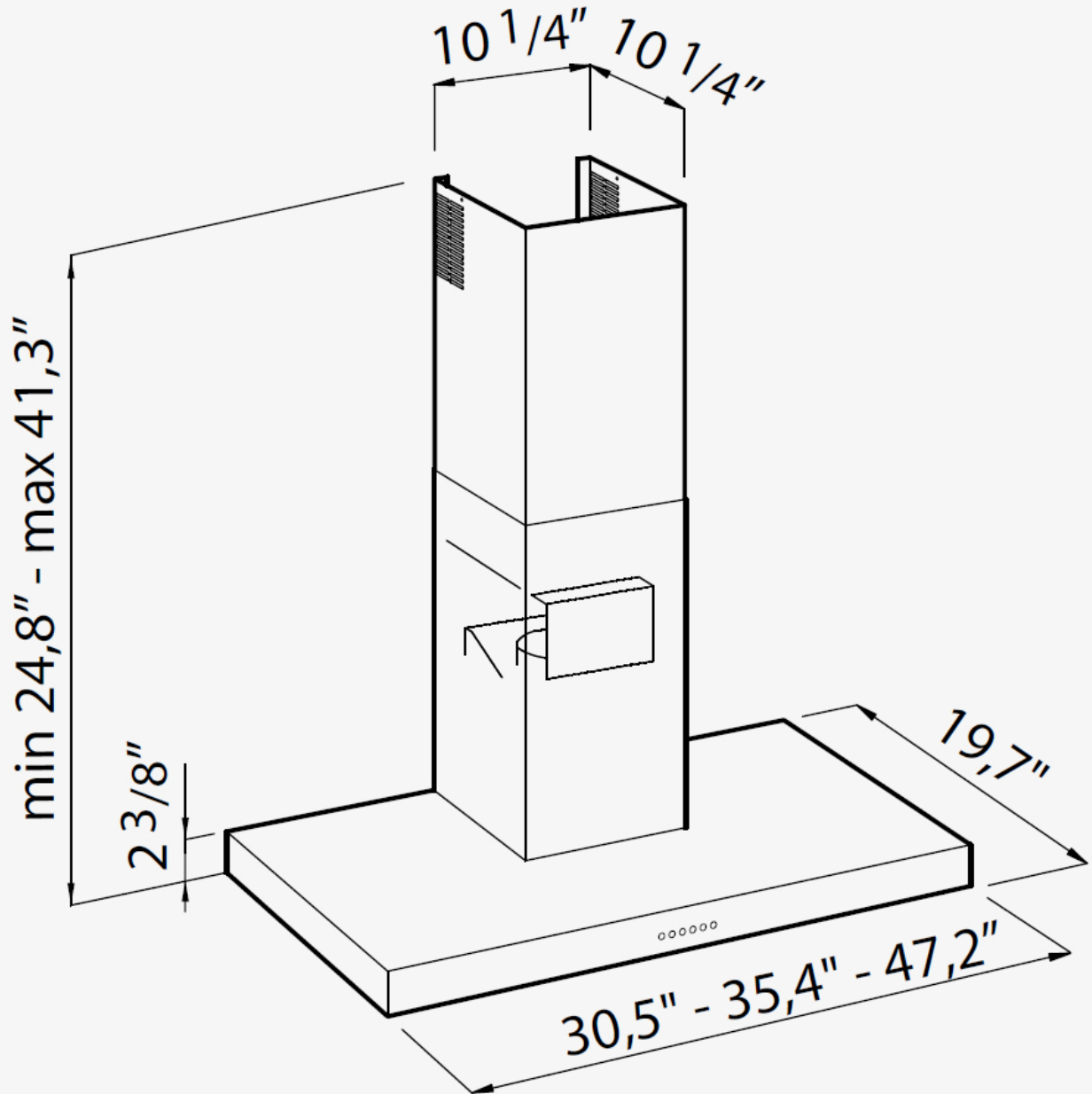

GALLERY

